

Ürün açıklaması/Ürün resimleri

**Açıklama****Malzeme:**

Çelik helezon.

Helezon dişli CuZn37Mn3Al2PbSi-S40.

Model:

Sağa doğru çıkan helezon, sertleştirilmiş HV 620 – 700, kenarlar ve delik taşlanmış.

Sipariş bilgisi:

Çarklar/helezonlar, sadece aynı aks mesafesi ve aynı aktarım oranı söz konusu olduğunda helezon dişli setinde kombine edilebilir.

Bilgi:

Helezon dişli seti, helezondan ve helezon dişlisinden oluşur. 90° aks açısına sahip helezon dişli kutularının üretilmesinde kullanılmaktadır. Helezon dişli kutuları ile, tek bir kademede yavaş hıza geçiş yapan büyük aktarımlar gerçekleştirilebilmektedir.

Dişlinin kenarı K biçimindedir. Tutma açısı 15°'dir. Helezon dişli setleri hazır delinmiş şekilde teslim edilir.

Belirtilen T2 tahrik çıkış torkları, helezon dişlide izin verilen tahrik çıkış torklarıdır. Bu değerler, helezonda 2800 dev/dak giriş devir sayısı için geçerlidir.

Helezon dişli setleri, yüksek devir sayılarında ve yüksek torklarda sürekli işletim için uygundur.

Çizim bilgisi:

1) taşlanmış





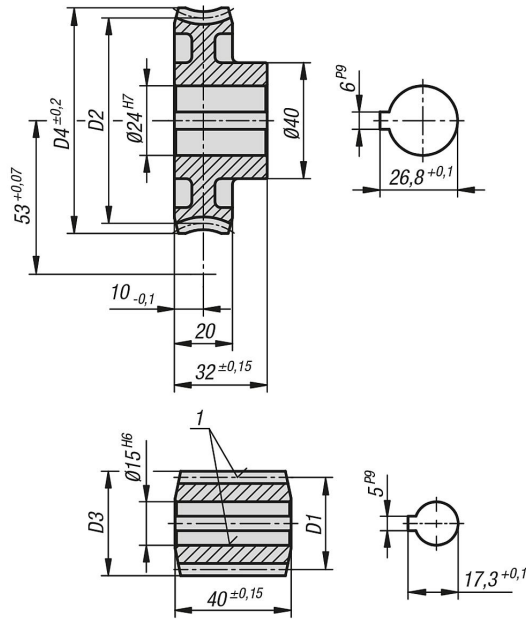

Ürün açıklaması/Ürün resimleri





















Çizimler



Ürünlere genel bakış

Sipariş numarası	Resim	Adı	Aktarma oranı	Eğim açısı	Modül	Z1	D1	D3	Z2	D2	D4	Çıkış torku T2 (Nm) Mineral gres	Çıkış torku T2 (Nm) Mineral yağ	Çıkış torku T2 (Nm) Sentetik yağ
22500-531004		Helezon	-	25° 51	3,5	4	32,1	39,1	-	-	-	-	-	-
22500-532004		Helezon dişli	4,75:1	25° 51	3,5	-	-	-	19	73,9	83	45	54	67,5
22500-531006		Helezon	-	19° 17	3,5	3	31,8	38,8	-	-	-	-	-	-
22500-532006		Helezon dişli	6,67:1	19° 17	3,5	-	-	-	20	74,2	84	67	81	101
22500-531008		Helezon	-	13° 52	2,5	3	31,29	36,29	-	-	-	-	-	-
22500-532009		Helezon dişli	9,67:1	13° 52	2,5	-	-	-	29	74,71	82	77	93	116
22500-531012		Helezon	-	10° 23	2,75	2	30,5	36	-	-	-	-	-	-
22500-532013		Helezon dişli	13,5:1	10° 23	2,75	-	-	-	27	75,5	84	80	96	120

Ürünler genel bakış

Sipariş numarası	Resim	Adı	Aktarma oranı	Eğim açısı	Modül	Z1	D1	D3	Z2	D2	D4	Çıkış torku T2 (Nm) Mineral gres	Çıkış torku T2 (Nm) Mineral yağ	Çıkış torku T2 (Nm) Sentetik yağ
22500-531013		Helezon	-	9° 38	2,5	2	29,9	34,9	-	-	-	-	-	-
22500-532015		Helezon dişli	15:1	9° 38	2,5	-	-	-	30	76,1	83	75	90	113
22500-531019		Helezon	-	6° 17	3,5	1	32	39	-	-	-	-	-	-
22500-532021		Helezon dişli	21:1	6° 17	3,5	-	-	-	21	74	83	94	113	141
22500-531023		Helezon	-	5° 38	3	1	30,58	36,58	-	-	-	-	-	-
22500-532025		Helezon dişli	25:1	5° 38	3	-	-	-	25	75,42	84	84	101	127
22500-531028		Helezon	-	3° 59	2,5	1	36	41	-	-	-	-	-	-
22500-532028		Helezon dişli	28:1	3° 59	2,5	-	-	-	28	70	77,5	87	104	130
22500-531027		Helezon	-	4° 40	2,5	1	30,73	35,73	-	-	-	-	-	-
22500-532030		Helezon dişli	30:1	4° 40	2,5	-	-	-	30	75,27	83	77	93	116
22500-531035		Helezon	-	3° 51	2	1	29,78	33,78	-	-	-	-	-	-
22500-532038		Helezon dişli	38:1	3° 51	2	-	-	-	38	76,21	83	68	81	102
22500-531046		Helezon	-	2° 47	1,5	1	30,85	33,85	-	-	-	-	-	-
22500-532050		Helezon dişli	50:1	2° 47	1,5	-	-	-	50	75,15	81	60	72	90
22500-531055		Helezon	-	2° 19	1,25	1	30,9	33,4	-	-	-	-	-	-
22500-532060		Helezon dişli	60:1	2° 19	1,25	-	-	-	60	75,1	80	55	66	82
22500-531075		Helezon	-	1° 51	1	1	30,9	32,9	-	-	-	-	-	-
22500-532075		Helezon dişli	75:1	1° 51	1	-	-	-	75	75,1	78	49	59	74