

Ürün açıklaması/Ürün resimleri

**Açıklama****Malzeme:**

Çelik helezon.

Helezon dişli CuZn37Mn3Al2PbSi-S40.

Model:

Sağa doğru çıkan helezon, sertleştirilmiş HV 620 – 700, kenarlar ve delik taşlanmış.

Sipariş bilgisi:

Çarklar/helezonlar, sadece aynı aks mesafesi ve aynı aktarım oranı söz konusu olduğunda helezon dişli setinde kombine edilebilir.

Bilgi:

Helezon dişli seti, helezondan ve helezon dişlisinden oluşur. 90° aks açısına sahip helezon dişli kutularının üretilmesinde kullanılmaktadır. Helezon dişli kutuları ile, tek bir kademede yavaş hıza geçiş yapan büyük aktarımlar gerçekleştirilebilmektedir.

Dişlinin kenarı K biçimindedir. Tutma açısı 15°'dir. Helezon dişli setleri hazır delinmiş şekilde teslim edilir.

Belirtilen T2 tahrik çıkış torkları, helezon dişlide izin verilen tahrik çıkış torklarıdır. Bu değerler, helezonda 2800 dev/dak giriş devir sayısı için geçerlidir.

Helezon dişli setleri, yüksek devir sayılarında ve yüksek torklarda sürekli işletim için uygundur.

Çizim bilgisi:

1) taşlanmış





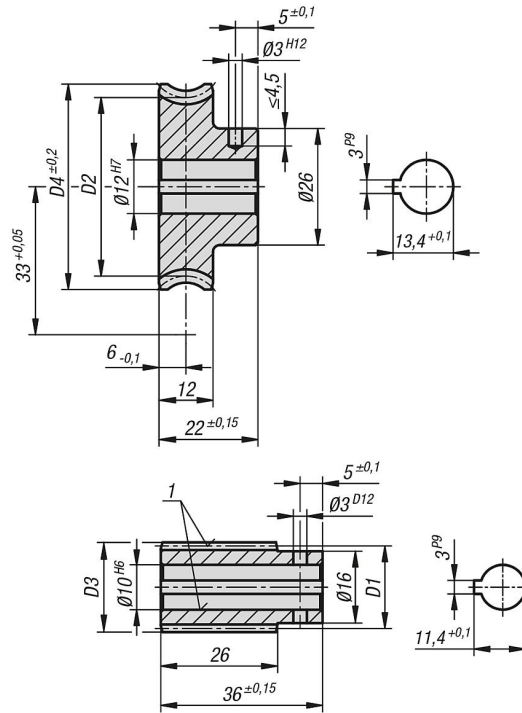

Ürün açıklaması/Ürün resimleri

























Çizimler















Ürünlere genel bakış

Sipariş numarası	Resim	Adı	Aktarma oranı	Eğim açısı	Modül	Z1	D1	D3	Z2	D2	D4	Çıkış torku T2 (Nm) Mineral gres	Çıkış torku T2 (Nm) Mineral yağ	Çıkış torku T2 (Nm) Sentetik yağ
22500-331003		Helezon	-	25° 57	1,75	6	24	27,5	-	-	-	10,1	12,1	15,1
22500-332003		Helezon dişli	3,5:1	25° 57	1,75	-	-	-	21	42	47	10,1	12,1	15,1
22500-331005		Helezon	-	20° 50	2	4	22,5	26,5	-	-	-	10,6	12,7	15,9
22500-332005		Helezon dişli	5:1	20° 50	2	-	-	-	20	43,5	49	10,6	12,7	15,9
22500-331007		Helezon	-	15° 32	1,5	4	22,4	25,4	-	-	-	12,2	14,6	18,3
22500-332007		Helezon dişli	7:1	15° 32	1,5	-	-	-	28	43,6	48	12,2	14,6	18,3
22500-331010		Helezon	-	13° 10	1,5	3	19,75	22,75	-	-	-	13,3	16	19,9

Ürünler genel bakış

Sipariş numarası	Resim	Adı	Aktarma oranı	Eğim açısı	Modül	Z1	D1	D3	Z2	D2	D4	Çıkış torku T2 (Nm) Mineral gres	Çıkış torku T2 (Nm) Mineral yağ	Çıkış torku T2 (Nm) Sentetik yağ
22500-332010		Helezon dişli	10:1	13° 10	1,5	-	-	-	30	46,25	51	13,3	16	19,9
22500-331011		Helezon	-	10° 42	1,3	3	21	23,6	-	-	-	13,3	16	19,9
22500-332011		Helezon dişli	11,33:1	10° 42	1,3	-	-	-	34	45	49,2	13,3	16	19,9
22500-331012		Helezon	-	11° 14	1,9	2	19,5	23,3	-	-	-	13,5	16,2	20,2
22500-332012		Helezon dişli	12:1	11° 14	1,9	-	-	-	24	46,5	52	13,5	16,2	20,2
22500-331015		Helezon	-	8° 25	1,5	2	20,5	23,5	-	-	-	13	15,6	19,5
22500-332015		Helezon dişli	15:1	8° 25	1,5	-	-	-	30	45,5	50	13	15,6	19,5
22500-331016		Helezon	-	10° 1	1,5	2	17,24	20,24	-	-	-	14	16,8	21
22500-332016		Helezon dişli	16:1	10° 1	1,5	-	-	-	32	48,76	53	14	16,8	21
22500-331017		Helezon	-	9° 3	1,4	2	17,8	20,6	-	-	-	14,2	17	21,3
22500-332017		Helezon dişli	17:1	9° 3	1,4	-	-	-	34	48,2	52,5	14,2	17	21,3
22500-331018		Helezon	-	6° 57	1,25	2	20,65	23,15	-	-	-	12,6	15,1	18,9
22500-332018		Helezon dişli	18:1	6° 57	1,25	-	-	-	36	45,35	49,2	12,6	15,1	18,9
22500-331020		Helezon	-	6° 43	1,15	2	19,66	21,96	-	-	-	12,7	15,2	19
22500-332020		Helezon dişli	20:1	6° 43	1,15	-	-	-	40	46,34	50,5	12,7	15,2	19
22500-331024		Helezon	-	5° 27	1,9	1	20	23,8	-	-	-	13,2	15,8	19,8
22500-332024		Helezon dişli	24:1	5° 27	1,9	-	-	-	24	46	51	13,2	15,8	19,8
22500-331028		Helezon	-	3° 36	1,5	1	23,9	26,9	-	-	-	11,2	13,4	16,8
22500-332028		Helezon dişli	28:1	3° 36	1,5	-	-	-	28	42,1	46,6	11,2	13,4	16,8
22500-331030		Helezon	-	4° 8	1,5	1	20,85	23,85	-	-	-	12,7	15,2	19
22500-332030		Helezon dişli	30:1	4° 8	1,5	-	-	-	30	45,15	50	12,7	15,2	19
22500-331032		Helezon	-	4° 50	1,5	1	17,8	20,8	-	-	-	13,5	16,2	20,2

Ürünler genel bakış

Sipariş numarası	Resim	Adı	Aktarma oranı	Eğim açısı	Modül	Z1	D1	D3	Z2	D2	D4	Çıkış torku T2 (Nm) Mineral gres	Çıkış torku T2 (Nm) Mineral yağ	Çıkış torku T2 (Nm) Sentetik yağ
22500-332032		Helezon dişli	32:1	4° 50	1,5	-	-	-	32	48,2	52,5	13,5	16,2	20,2
22500-331038		Helezon	-	3° 55	1,25	1	18,28	20,76	-	-	-	13,9	16,7	20,8
22500-332038		Helezon dişli	38:1	3° 55	1,25	-	-	-	38	47,74	51,6	13,9	16,7	20,8
22500-331050		Helezon	-	2° 27	0,9	1	21	22,8	-	-	-	10	12	15
22500-332050		Helezon dişli	50:1	2° 27	0,9	-	-	-	50	45	48	10	12	15
22500-331056		Helezon	-	2° 10	0,8	1	21,15	22,75	-	-	-	10,1	12,1	15,1
22500-332056		Helezon dişli	56:1	2° 10	0,8	-	-	-	56	44,85	48	10,1	12,1	15,1
22500-331060		Helezon	-	2° 33	0,8	1	17,96	19,56	-	-	-	11,4	13,7	17,1
22500-332060		Helezon dişli	60:1	2° 33	0,8	-	-	-	60	48,04	51,5	11,4	13,7	17,1
22500-331072		Helezon	-	1° 30	0,6	1	22,8	24	-	-	-	8,4	10,01	12,6
22500-332072		Helezon dişli	72:1	1° 30	0,6	-	-	-	72	43,2	46	8,4	10,01	12,6
22500-331075		Helezon	-	1° 41	0,6	1	20,5	21,7	-	-	-	9	10,8	13,5
22500-332075		Helezon dişli	75:1	1° 41	0,6	-	-	-	75	45,5	48	9	10,8	13,5